

# Kitchen Planning Guidelines With Access Standards

## 1: Door/Entry

---

### Recommended:

The clear opening of a doorway should be at least 32'' wide. This would require a minimum 2'-10'' door.

### Code Requirement:

State or local codes may apply.

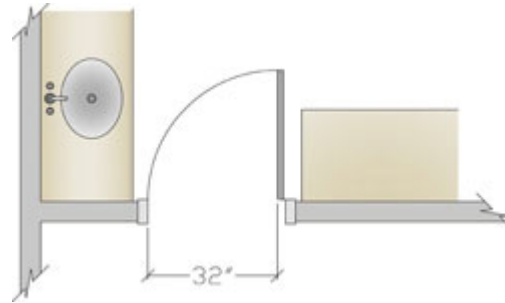

3'-0" DOOR 90  
DEGREE SWING  
(ACCESS STANDARD 1)

### Access Standard

### Recommended:

The clear opening of a doorway should be at least 34''. This would require a minimum 3'-0'' door.

### Code Reference:

Clear openings of doorways with swinging doors shall be measured between the face of door and stop, with the door open 90 degrees. (ANSI 404.2.3)

When a passage exceeds 24" in depth, the minimum clear opening increases to 36". (ANSI A117.1 404)

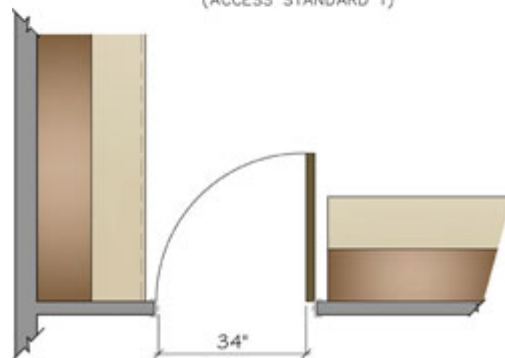

24" DEPTH CLEARANCE  
(ACCESS STANDARD 1-ANSI)

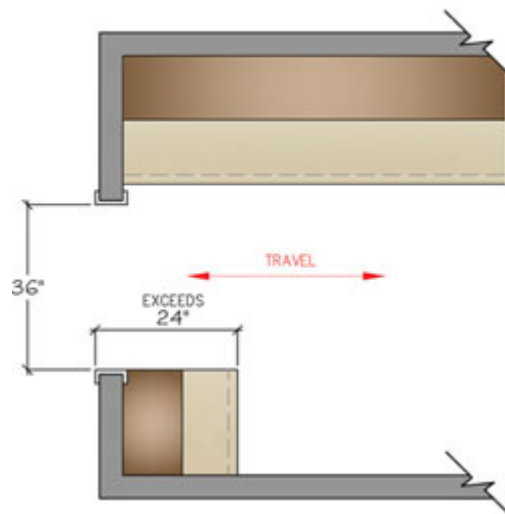

36"

EXCEEDS  
24"

TRAVEL

## 2:Door Interference

### Recommended:

No entry door should interfere with the safe operation of appliances, nor should appliance doors interfere with one another.

### Code Requirement:

State or local codes may apply.

### Access Standard

### Recommended:

In addition, the door area should include clear floor space for maneuvering which varies according to the type of door and direction of approach.

### Code Reference:

For a standard hinged or swinging door, the clearance on the pull side of the door should be the door width plus 18" by 60".

(ANSI A 117.1 404.2.3.1)

The clearance on the push side of the door should be the door width by 48".

(ANSI A 117.1 404.2.3.1)

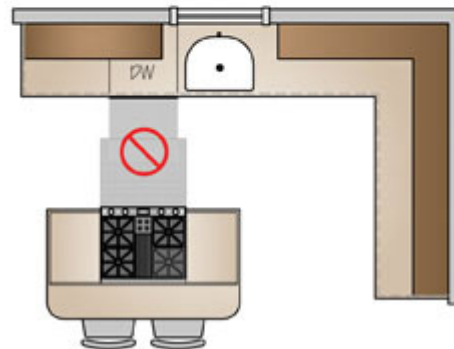
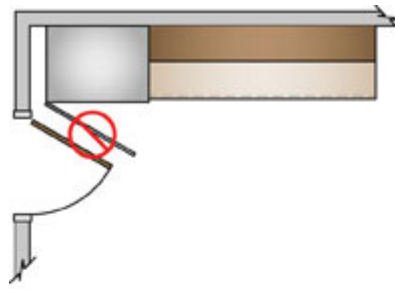

FRONT APPROACH TO SWING DOORS (ACCESS STANDARD 2)

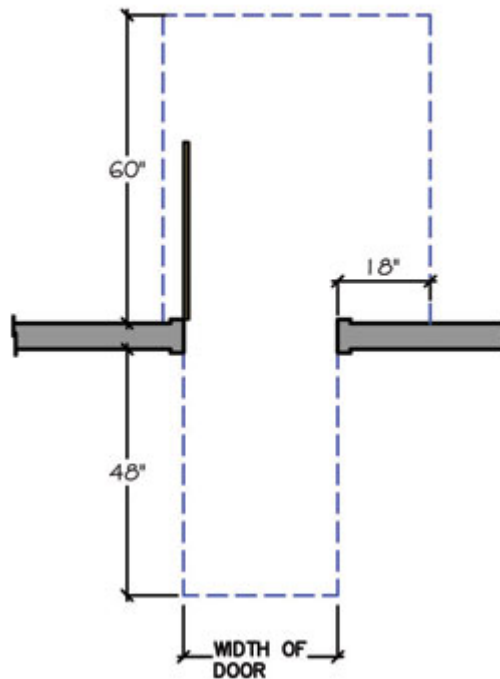

### 3: Distance Between Work Centers

---

#### **Recommended:**

In a kitchen with three work centers\* the sum of the three traveled distances should total no more than 26' with no single leg of the triangle measuring less than 4' nor more than 9'.

When the kitchen plan includes more than three primary appliance/work centers, each additional travel distance to another appliance/work center should measure no less than 4' nor more than 9'.

Each leg is measured from the center-front of the appliance/sink.

No work triangle leg intersects an island/peninsula or other obstacle by more than 12".

\*A major appliance and its surrounding landing/work area form a work center. The distances between the three primary work centers (cooking surface, cleanup/prep sink and refrigeration storage) form a work triangle.

#### **Code Requirement:**

State or local codes may apply.

#### **Access Standard**

#### **Recommended:**

Kitchen guideline recommendation meets Access Standard.

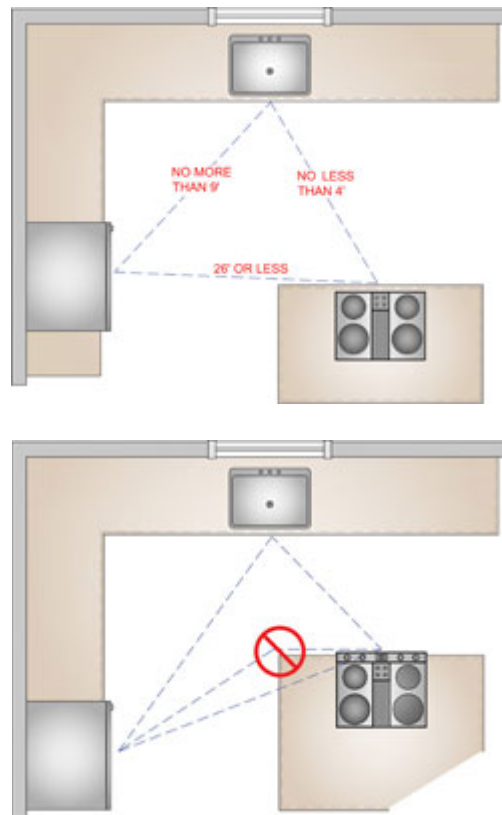

#### 4: Separating Work Centers

---

**Recommended:**

A full-height, full-depth, tall obstacle\* should not separate two primary work centers.

A properly recessed tall corner unit will not interrupt the workflow and is acceptable.

\*Examples of a full-height obstacle are a tall oven cabinet, tall pantry cabinet or refrigerator.

**Code Requirement:**

State or local codes may apply.

**Access Standard**

**Recommended:**

Kitchen guideline recommendation meets Access Standard.

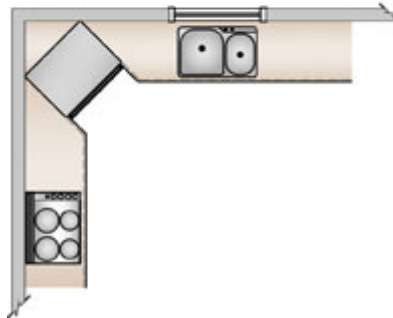

#### 5: Work Triangle Traffic

---

**Recommended:**

No major traffic patterns should cross through the basic work triangle.

**Code Requirement:**

State or local codes may apply.

**Access Standard**

**Recommended:**

Kitchen guideline recommendation meets Access Standard.

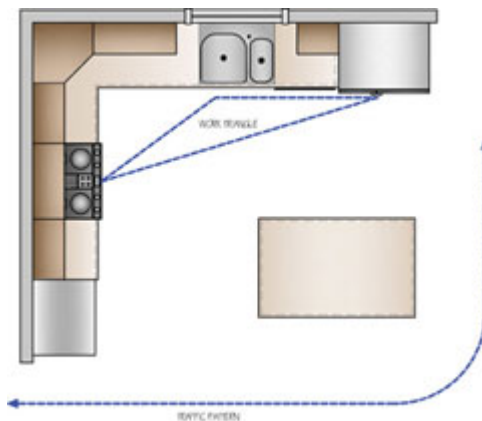

## 6: Work Aisle

### Recommended:

The width of a work aisle should be at least 42" for one cook and at least 48" for multiple cooks. Measure between the counter frontage, tall cabinets and/or appliances.

### Code Requirement:

State or local codes may apply.

### Access Standard

**Recommended:** Kitchen guideline recommendation meets Access Standard recommendation. See Code References for specific applications.

### Code Reference:

A clear floor space of at least 30" by 48" should be provided at each kitchen appliance. Clear floor spaces can overlap. (ANSI A 117.1 305.3, 804.6.1)

In a U-shaped kitchen, plan a minimum clearance of 60" between opposing arms. (ANSI A117.1 804.2.2, 1003.12.1.2)

Include a wheelchair turning space with a diameter of at least 60", which can include knee\* and toe\* clearances. (ANSI A117.1 304.3.1).

A wheelchair turning space could utilize a T-shaped clear space, which is a 60" square with two 12" wide x 24" deep areas removed from the corners of the square. This leaves a minimum 36" wide base and two 36" wide arms. T-shaped wheelchair turning spaces can include knee and toe clearances. (ANSI A117.1 304.3.2)

*\* Knee clearance must be 30" wide and maintain a 27" clear space under the cabinet, counter, or sink for a depth of 8". The next 11" of depth may slope down to a height of 9", with a clear space of at least*

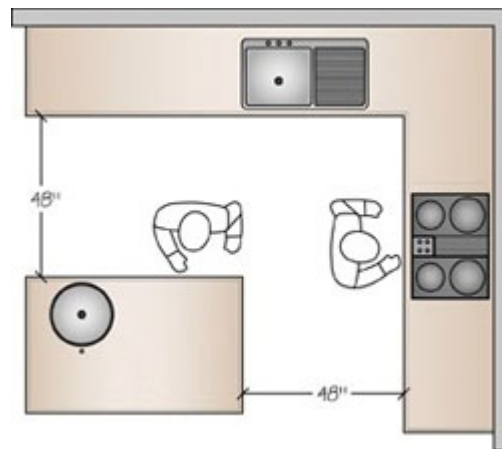
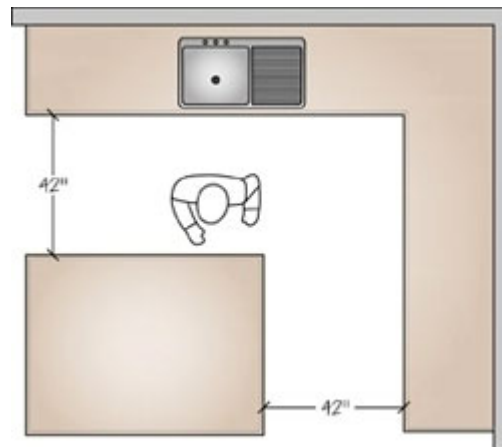

17" extending beneath the element.

\* Toe clearance space under a cabinet or appliance is between the floor and 9" above the floor. Where toe clearance is required as part of a clear floor space, the toe clearance should extend 17" minimum beneath the element. (ANSI A117.1 306.2)

**Code Reference:**

State or local codes may apply.

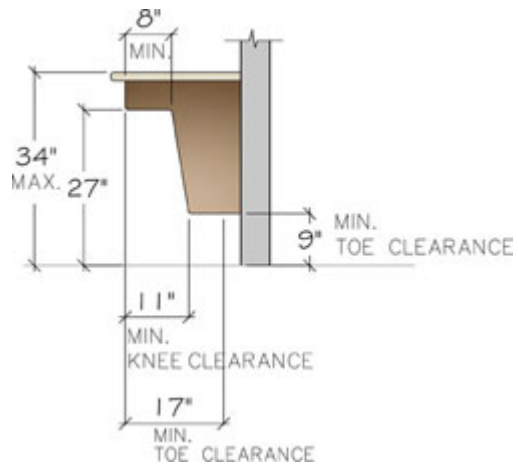
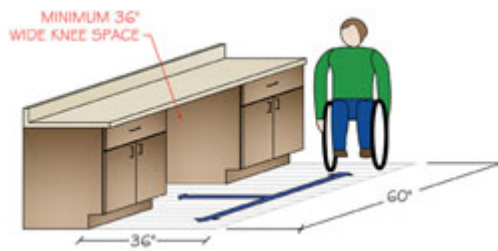
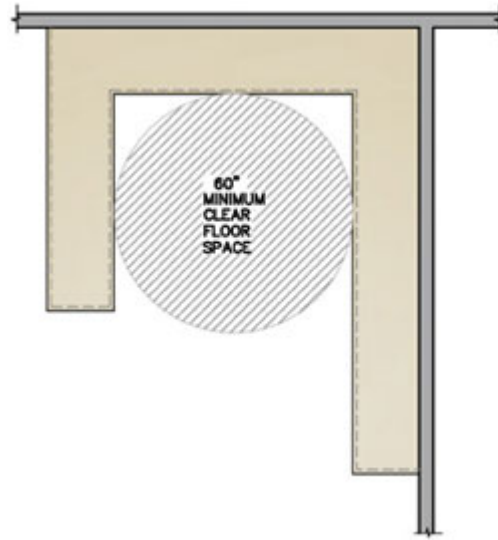

## 7: Walkway

---

### **Recommended:**

The width of a walkway should be at least 36".

### **Code Requirement:**

State or local codes may apply.

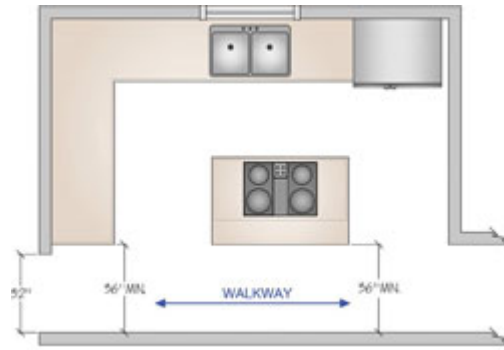

### **Access Standard**

### **Recommended:**

If two walkways are perpendicular to each other, one walkway should be at least 42" wide.

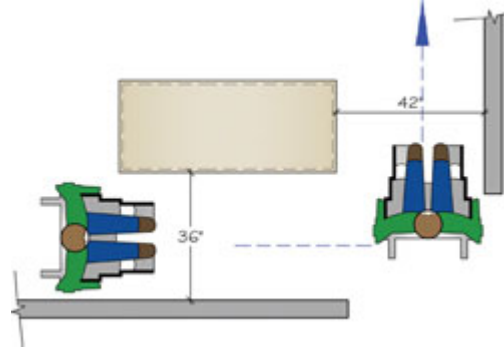

## 8: Traffic Clearance at Seating

### Recommended:

In a seating area where no traffic passes behind a seated diner, allow 32" of clearance from the counter/table edge to any wall or other obstruction behind the seating area.

- If traffic passes behind the seated diner, allow at least 36" to edge past.
- If traffic passes behind the seated diner, allow at least 44" to walk past.

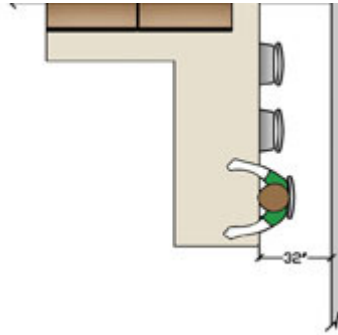

### Code Requirement:

State or local codes may apply.

### Access Standard

#### Recommended:

In a seating area where no traffic passes behind a seated diner allow 36" of clearance from the counter/table edge to any wall or other obstruction behind the seating area.

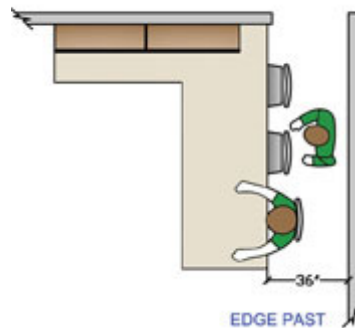

If traffic passes behind the seated diner, plan a minimum of 60" to allow passage for a person in a wheelchair.

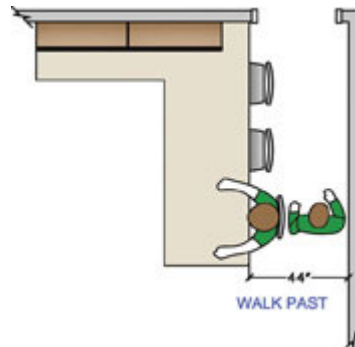



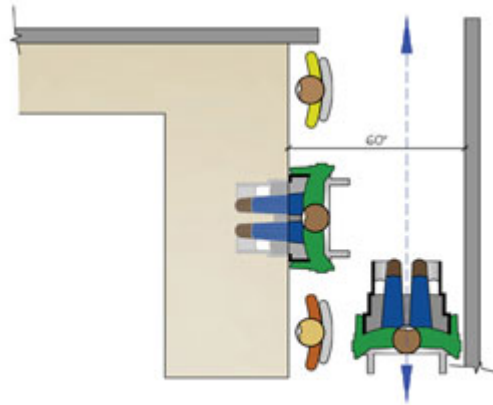
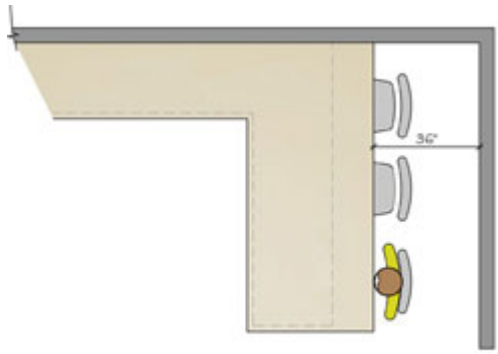

WHEN USED AS  
WALKWAY SPACE

## 9: Seating Clearance

### Recommended:

Kitchen seating areas should incorporate at least the following clearances:

- a. 30" high tables/counters: Allow a 24" wide x 18" deep knee space for each seated diner and at least 18" of clear knee space
- b. 36" high counters: Allow a 24" wide x 15" deep knee space for each seated diner and at least 15" of clear knee space.
- c. 42" high counters: Allow a 24" wide x 12" deep knee space for each seated diner and 12" of clear knee space.

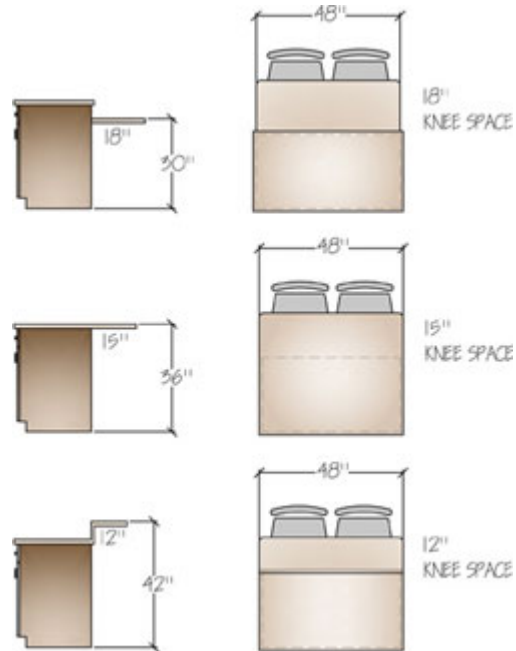

### Code Requirement:

State or local codes may apply.

### Access Standard

#### Recommended:

Kitchen seating areas should be 28" – 34" high x 30" – 36" wide x 19" deep to better accommodate people of various sizes or those using a mobility aid.

Recommended minimum size for a knee space at a table or counter is 36" wide x 27" high x 19" deep.

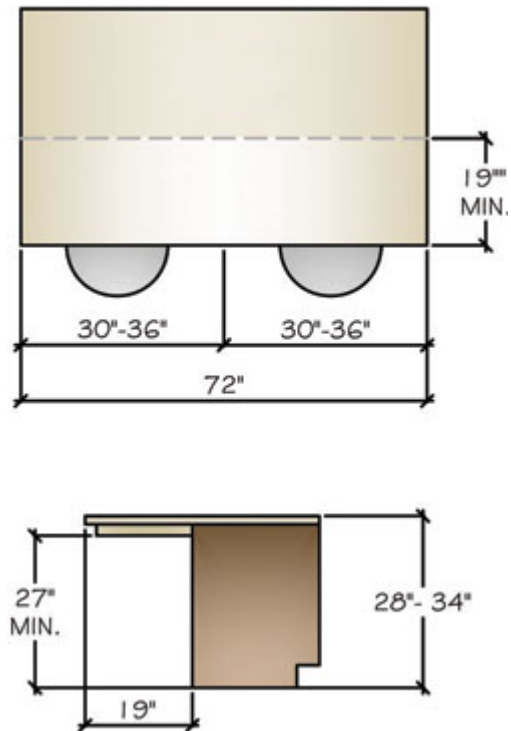

## 10: Cleanup/Prep Sink Placement

---

### Recommended:

If a kitchen has only one sink, locate it adjacent to or across from the cooking surface and refrigerator.

### Code Requirement:

State or local codes may apply.

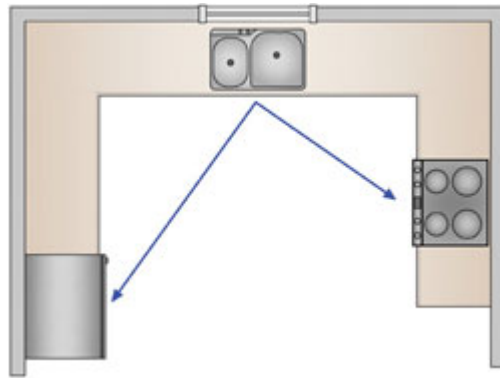

### Access Standard

### Recommended:

Plan knee spaces at the sink to allow for a seated user. Recommended minimum size for a knee space is 36" wide x 27" high x 8" deep, increasing to 17" deep in the toe space, which extends 9" from the floor. Insulation for exposed pipes should be provided.

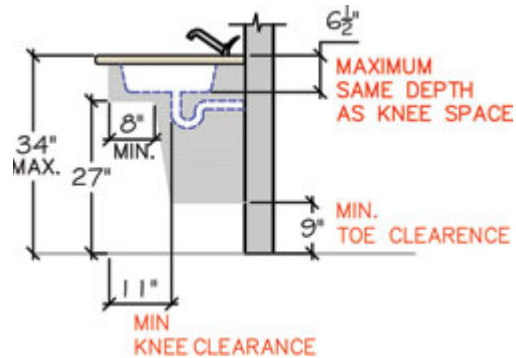

### Code Reference:

The sink should be no more than 34" high or adjustable between 29" and 36". (ANSI 117.1.1002.4.2)

The sink bowl should be no more than 6 1/2" deep (ANSI 117.1 1002.12.4.3).

Exposed water supply and drainpipes under sinks should be insulated or otherwise configured to protect against contact. There should be no sharp or abrasive surfaces under sinks. (ANSI A117.1 606.6)

## 11: Cleanup/Prep Sink Landing Area

---

### **Recommended:**

Include at least a 24" wide landing area\* to one side of the sink and at least an 18" wide landing area on the other side.

If all of the countertop at the sink is not the same height, then plan a 24" landing area on one side of the sink and 3" of countertop frontage on the other side, both at the same height as the sink.

The 24" of recommended landing area can be met by 3" of countertop frontage from the edge of the sink to the inside corner of the countertop if more than 21" of countertop frontage is available on the return.

*\*Landing area is measured as countertop frontage adjacent to a sink and/or an appliance. The countertop must be at least 16" deep and must be 28" to 45" above the finished floor to qualify.*

### **Code Requirement:**

State or local codes may apply.

### **Access Standard**

### **Recommended:**

Kitchen guideline recommendation meets Access Standard.

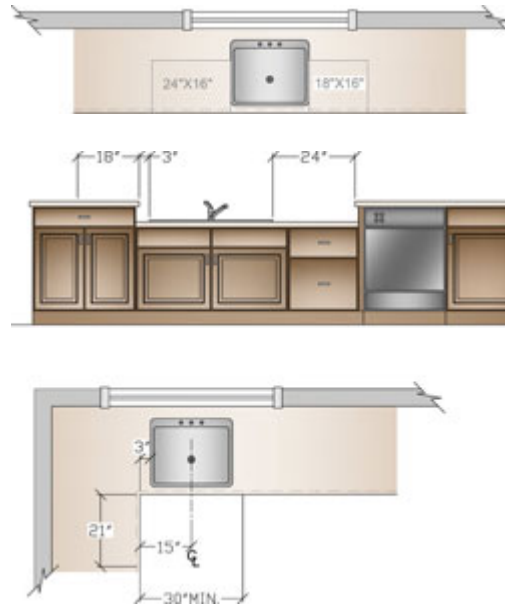

## 12: Preparation/Work Area

---

### Recommended:

Include a section of continuous countertop at least 36" wide x 24" deep immediately next to a sink for a primary preparation/work area.

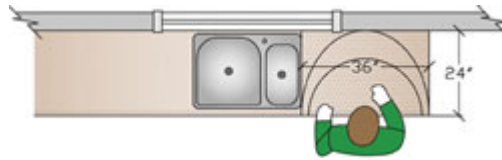

### Code Requirement:

State or local codes may apply.

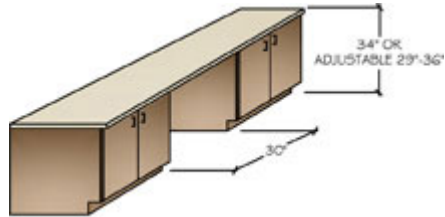

### Access Standard

### Recommended:

A section of continuous countertop at least 30" wide with a permanent or adaptable knee space should be included somewhere in the kitchen.

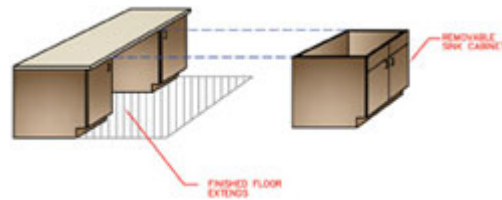

See Access Guideline 6 for knee space specifications.

### Code Reference:

In a kitchen, there should be at least one 30" wide section of counter, 34" high maximum or adjustable from 29" to 36". Cabinetry can be added under the work surface, provided it can be removed or altered without removal or replacement of the work surface, and provided the finished floor extends under the cabinet. (ANSI A 117.1 8.04.6.3, 1003.12.6.3)

### 13: Dishwasher Placement

---

#### Recommended:

Locate nearest edge of the primary dishwasher within 36" of the nearest edge of a cleanup/prep sink.

Provide at least 21"\* of standing space between the edge of the dishwasher and countertop frontage, appliances and/or cabinets, which are placed at a right angle to the dishwasher.

*\*In a diagonal installation, the 21" is measured from the center of the sink to the edge of the dishwasher door in an open position.*

#### Code Requirement:

State or local codes may apply.

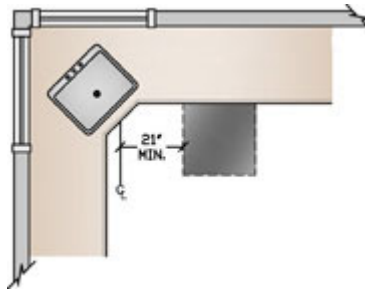
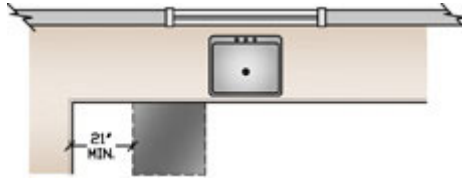
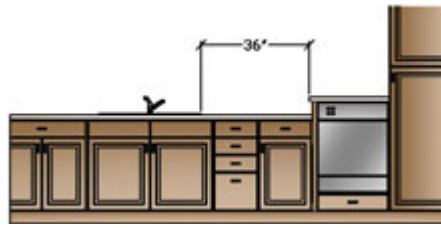

#### Access Standard

#### Recommended:

Raise dishwasher 6" – 12" when it can be planned with appropriate landing areas at the same height as the sink.

#### Code Reference:

A clear floor space of at least 30" x 48" should be positioned adjacent to the dishwasher door. The dishwasher door in the open position should not obstruct the clear floor space for the dishwasher or the sink. (ANSI A 117.1 804.6.3, 1003.12.6.3)

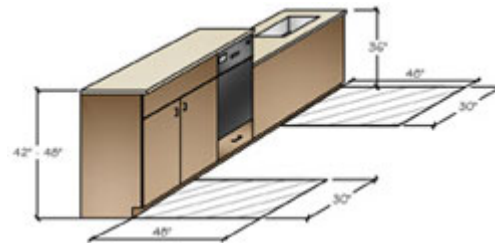

## 14: Waste Receptacles

---

### Recommended:

Include at least two waste receptacles. Locate one near each of the cleanup/prep sink(s) and a second for recycling either in the kitchen or nearby.

### Code Requirement:

State or local codes may apply.

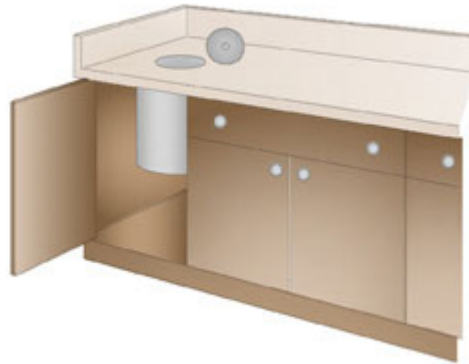

### Access Standard

### Recommended:

Kitchen guideline recommendation meets Access Standard.

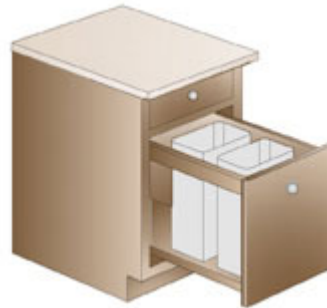

## 15: Auxiliary Sink

---

### Recommended:

At least 3" of countertop frontage should be provided on one side of the auxiliary sink, and 18" of countertop frontage on the other side, both at the same height as the sink.

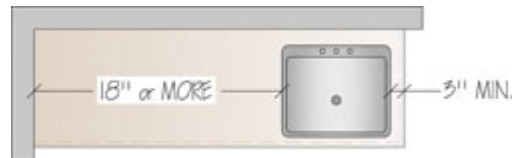

### Code Requirement:

State or local codes may apply.

### Access Standard

### Recommended:

Plan a knee space at, or adjacent to, the auxiliary sink.

See Access Standard 6 for knee space specifications.

---

## 16: Refrigerator Landing Area

---

### Recommended:

Include at least:

- a. 15" of landing area on the handle side of the refrigerator or
- b. 15" of landing area on either side of a side-by-side refrigerator or
- c. 15" of landing area which is no more than 48" across from the front of the refrigerator or
- d. 15" of landing area above or adjacent to any undercounter style refrigeration appliance.

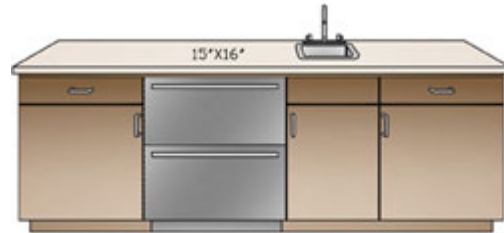
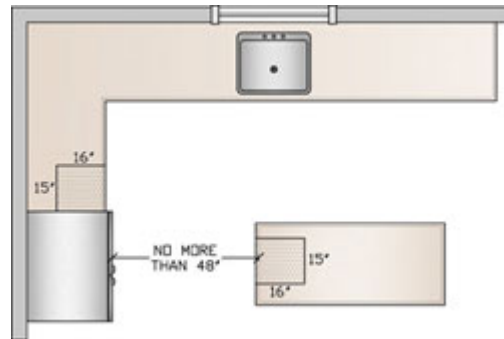

### Code Requirement:

State or local codes may apply.

### Access Standard

#### Recommended:

See Code Reference

#### Code Reference:

A clear floor space of 30" x 48" should be positioned for a parallel approach to the refrigerator/freezer with the centerline of the clear floor space offset 24" maximum from the centerline of the appliance. (ANSI A 117.1 804.6.6, 1003.12.6.6)

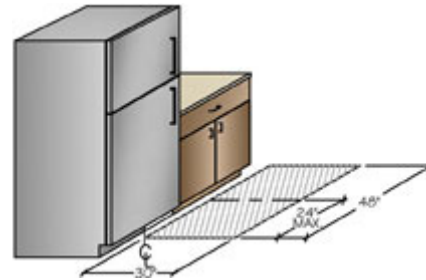



## 17: Cook Surface Landing Area

### Recommended:

Include a minimum of 12" of landing area on one side of a cooking surface and 15" on the other side.

If the cooking surface is at a different countertop height than the rest of the kitchen then the 12" and 15" landing areas must be at the same height as the cooking surface.

For safety reasons, in an island or peninsula situation, the countertop should also extend a minimum of 9" behind the cooking surface if the counter height is the same as the surface-cooking appliance.

For an enclosed configuration, a reduction of clearances shall be in accordance with the appliance manufacturer's instructions or per local codes. (This may not provide adequate landing area.)

### Code Requirement:

State or local codes may apply.

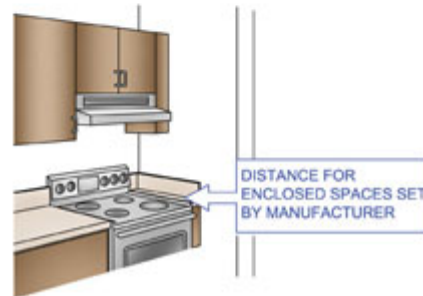
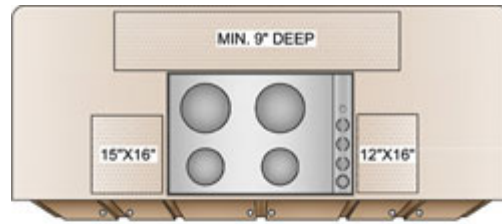

### Access Standard

#### Recommended:

Lower the cooktop to 34" maximum height and create a knee space beneath the appliance.

See Access Standard 6 for knee space specifications.

#### Code Reference:

When a forward-approach clear floor space is provided at the cooktop, it should provide knee and toe clearance and the underside of the cooktop should be insulated or otherwise configured to prevent burns, abrasions, or electric shock. (ANSI 1002.12.6.4)

The location of cooktop controls should not require reaching across

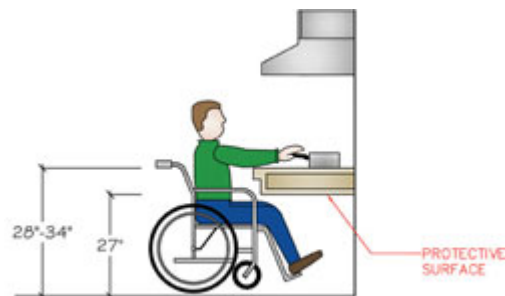

burners. (ANSI 1003.12.6.4)

## 18: Cooking Surface Clearance

---

### Recommended:

Allow 24" of clearance between the cooking surface and a protected noncombustible surface above it.

### Code Requirement:

At least 30" of clearance is required between the cooking surface and an unprotected/combustible surface above it. (IRC M 1901.1)

If a microwave hood combination is used above the cooking surface, then the manufacturer's specifications should be followed. (IRC M 1504.1)

Refer to manufacturer's specifications or local building codes for other considerations.

### Access Standard

#### Recommended:

Kitchen guideline recommendation meets Access Standard.

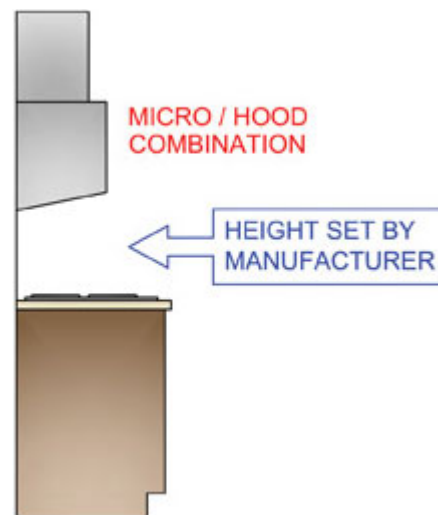
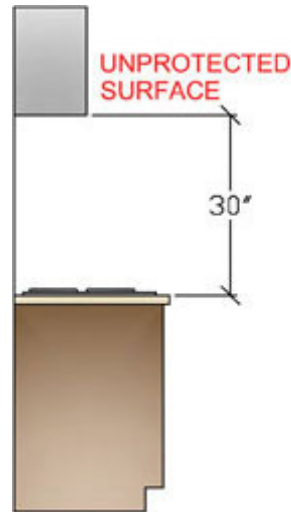
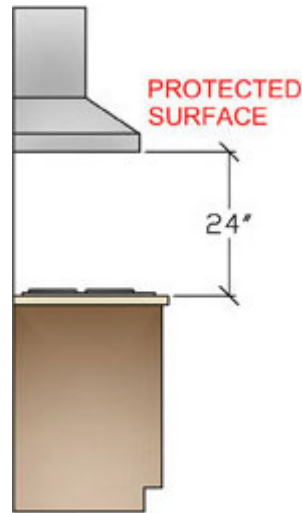

## 19: Cooking Surface Ventilation

---

### Recommended:

Provide a correctly sized, ducted ventilation system for all cooking surface appliances. The recommended minimum is 150 cfm.

### Code Requirement:

Manufacturer's specifications must be followed. (IRC G 2407.1, IRC G 2447.1)

The minimum required exhaust rate for a ducted hood is 100 cfm and must be ducted to the outside. (IRC M 1507.3)

Make-up air may need to be provided. Refer to local codes. (IRC G 2407.4)

### Access Standard

#### Recommended:

Ventilation controls should be placed 15" – 44" above the floor, operable with minimal effort, easy to read and with minimal noise pollution.

#### Code Reference:

Operable parts should be operable with one hand and not require tight grasping, pitching or twisting of the wrist. The force required to activate operable parts should be 5 pounds maximum. (ANSI A117.1 309.4)

Where a forward or side reach is unobstructed, the high reach should be 48" maximum and the low reach should be 15" minimum above the floor. (ANSI A117.1 308.2.1 and 308.3.1)

Where a forward or side reach is obstructed by a 20" – 25" deep counter, the high reach should be 44" maximum. (ANSI A117.1 308.2.2)

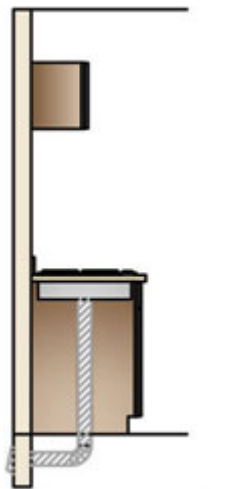
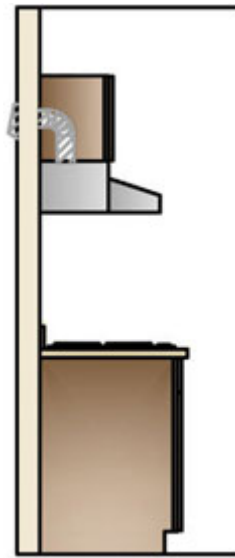

MINIMUM 150 CFM

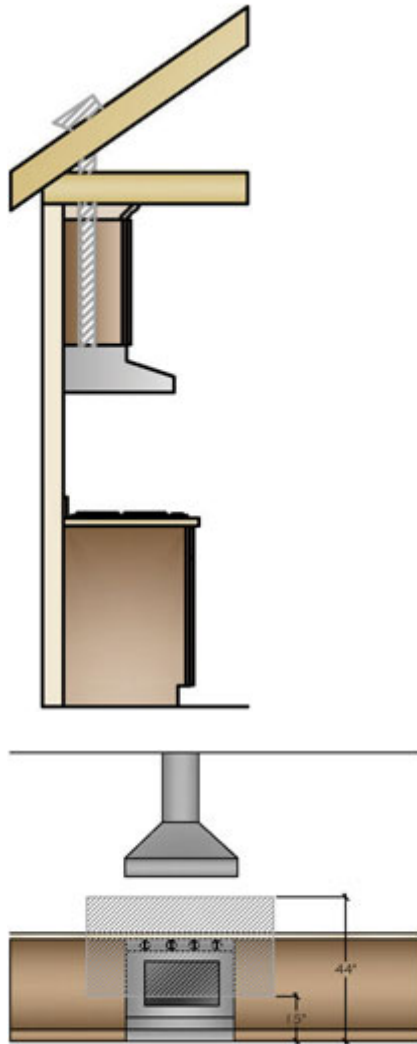

VENTILATION CONTROLS  
WITHIN 15"–44"  
REACH CONTROL

## 20: Cooking Surface Safety

---

### Recommended:

- a. Do not locate the cooking surface under an operable window.
- b. Window treatments above the cooking surface should not use flammable materials.
- c. A fire extinguisher should be located near the exit of the kitchen away from cooking equipment.

### Code Requirement:

State or local codes may apply.



UNACCEPTABLE

### Access Standard

#### Recommended:

Place fire extinguisher between 15" and 48" off the finished floor.



ACCEPTABLE

---

## 21: Microwave Oven Placement

---

### Recommended:

Locate the microwave oven after considering the user's height and abilities. The ideal location for the bottom of the microwave is 3" below the principle user's shoulder but no more than 54" above the floor.

If the microwave oven is placed below the countertop the oven bottom must be at least 15" off the finished floor.

### Code Requirement:

State or local codes may apply.

### Access Standard

### Recommended:

Locate the microwave controls below 48."

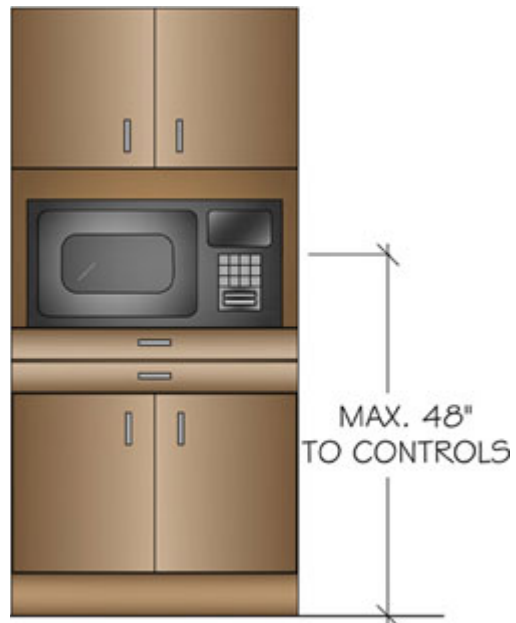
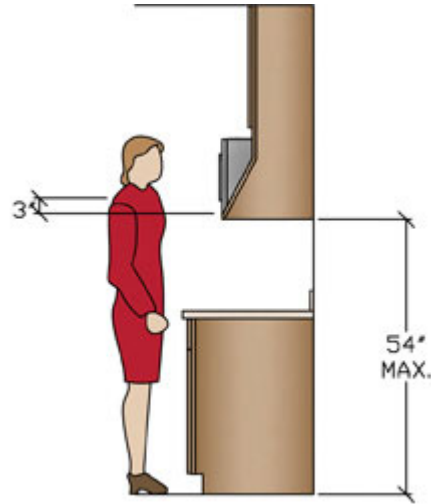
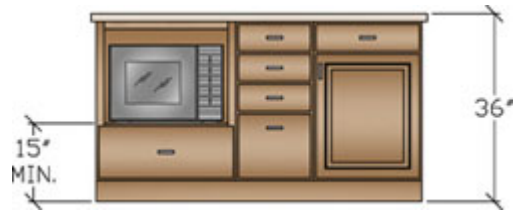

## 22: Microwave Landing Area

---

### Recommended:

Provide at least a 15" landing area above, below, or adjacent to the handle side of a microwave oven.

### Code Requirement:

State or local codes may apply.

### Access Standard

### Recommended:

Provide landing area in front of or immediately adjacent to the handle side of the microwave.

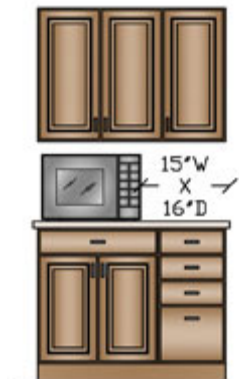
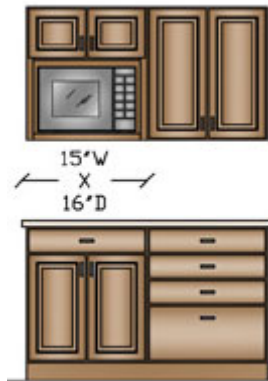
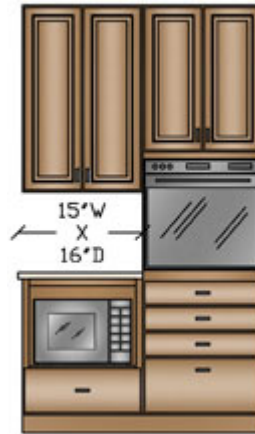



## 23: Oven Landing Area

---

### Recommended:

Include at least a 15" landing area next to or above the oven.

At least a 15" landing area that is not more than 48" across from the oven is acceptable if the appliance does not open into a walkway.

### Code Requirement:

State or local codes may apply.

### Access Standard

### Recommended:

See Code reference

### Code Reference:

For side-opening ovens, the door latch side should be next to a countertop (ANSI A 117.1 804.6.5.1)

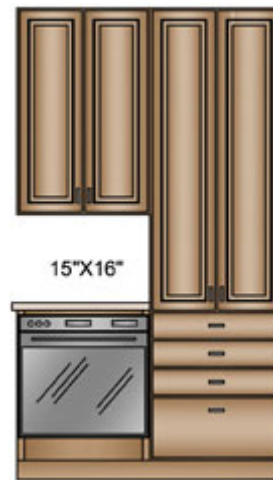
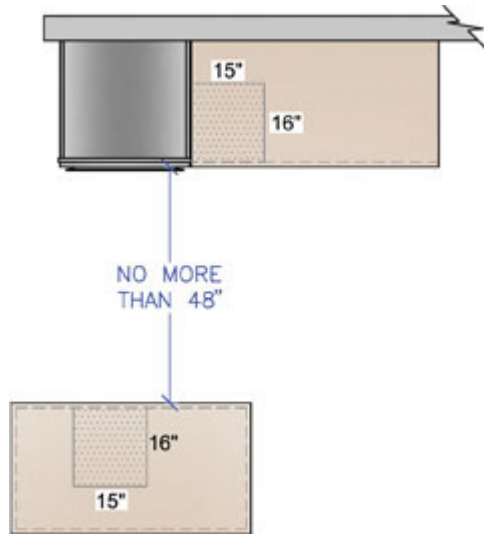

## 24: Combining Landing Areas

### Recommended:

If two landing areas are adjacent to one another, determine a new minimum for the two adjoining spaces by taking the longer of the two landing area requirements and adding 12.”

### Code Requirement:

State or local codes may apply.

### Access Standard

### Recommended:

Kitchen guideline recommendation meets Access Standard.

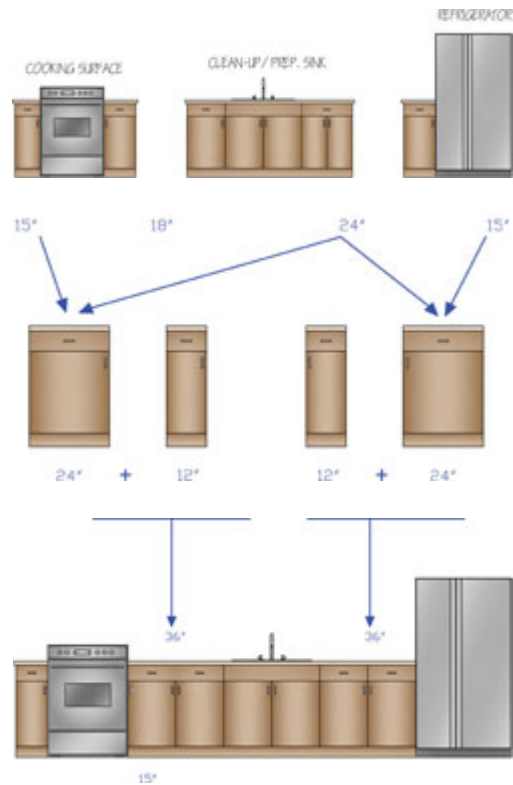

## 25: Countertop Space

### Recommended:

A total of 158” of countertop frontage, 24” deep, with at least 15” of clearance above, is needed to accommodate all uses, including landing area, preparation/work area, and storage.

Built-in appliance garages extending to the countertop can be counted towards the total countertop frontage recommendation, but they may interfere with the landing areas.

**Code Requirement:** State or local codes may apply.

### Access Standard

### Recommended:

At least two work-counter heights should be offered in the kitchen, with one 28”– 36” above the finished floor and the other 36”– 45” above the finished floor.



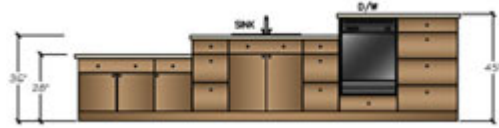

## 26: Countertop Edges

---

### **Recommended:**

Specify clipped or round corners rather than sharp edges on all counters.

### **Code Requirement:**

State or local codes may apply.

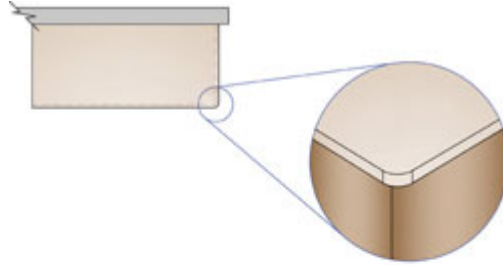

### **Access Standard**

### **Recommended:**

Kitchen guideline recommendation meets Access Standard.

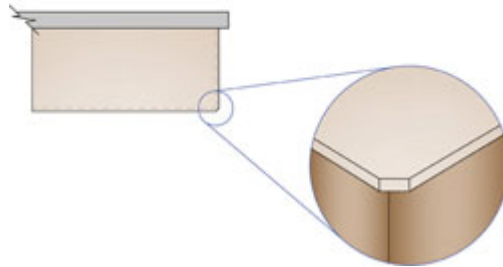

## 27: Storage

### Recommended:

The total shelf/drawer frontage\* is:

- a. 1400" for a small kitchen (less than 150 square feet);
- b. 1700" for a medium kitchen (151 to 350 square feet); and
- c. 2000" for a large kitchen (greater than 350 square feet).

**The recommended distribution for the shelf/drawer frontage in inches is:**

	Small	Medium	Large
Wall	300"	360"	360"
Base	520"	615"	660"
Drawer	360"	400"	525"
Pantry	180"	230"	310"
Misc.	40"	95"	145"

The totals for wall, base, drawer and pantry shelf/ drawer frontage can be adjusted upward or downward as long as the recommended total stays the same.

Do not apply more than the recommended amount of storage in the miscellaneous category to meet the total frontage recommendation.

Storage areas that are more than 84" above the floor must be counted in the miscellaneous category.

*\*Shelf and drawer frontage is determined by multiplying the cabinet size by the number and depth of the shelves or drawers in the cabinet, using the following formula:*

*Cabinet width in inches x number of shelf/drawers x cabinet depth in feet (or fraction thereof) = Shelf/Drawer Frontage*

*Storage/organizing items can enhance the functional capacity of wall, base, drawer and pantry storage and should be selected to meet user needs.*

← 24" →      ← 24" →

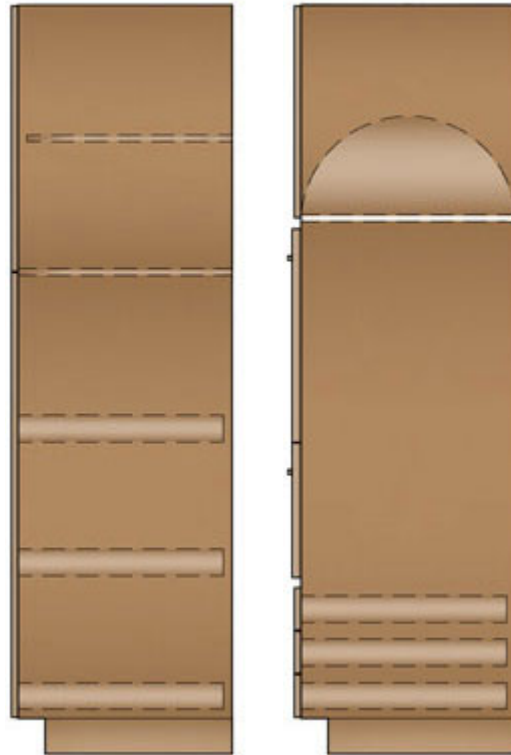

2 shelves 24" x 2' = 96" pantry storage  
+3 drawers 24" x 2' = 144" drawer storage  
Total: 144" drawer storage and 96" pantry storage

Tray dividers 30" x 2' = 60" pantry storage  
+3 drawers 30" x 2' = 180" drawer storage  
Total: 180" drawer storage and 60" pantry storage

← 24" →      ← 24" →

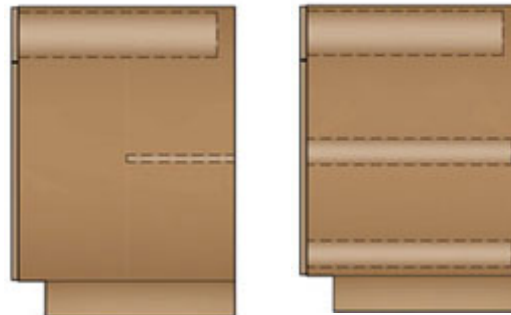

1 drawer 24" x 2' = 48" drawer storage  
+1 shelf 24" x 1' = 24" base storage  
+1 shelf (bottom) 24" x 2' = 48" base storage  
Total: 48" drawer storage and 72" base storage

1 drawer 24" x 2' = 48" drawer storage  
+2 roll-outs 24" x 2' = 96" drawer storage  
Total: 144" drawer storage

**Code Requirement:**

State or local codes may apply.

**Access Standard**

**Recommended:**

Plan storage of frequently used items 15" to 48" above the floor.

**Code Reference:**

Where a forward or side reach is unobstructed, the high reach should be 48" maximum and the low reach should be 15" minimum above the floor. (ANSI A117.1 308.2.1 and 308.3.1)

Where a 20" – 25" deep counter obstructs a forward or side reach, the high reach should be 44" maximum. (ANSI A117.1 308.2.2)



1 drawer 18" x 1 3/4' = 31 1/2" drawer storage  
+1 shelf 18" x 1' = 18" base storage  
+1 shelf (bottom) 18" x 1 3/4' = 31 1/2" base storage  
Total: 31 1/2" drawer storage and 49 1/2" base storage



1 drawer 18" x 1 3/4' = 31 1/2" drawer storage  
+2 roll outs 18" x 1 3/4' = 63" drawer storage  
Total: 94 1/2" drawer storage

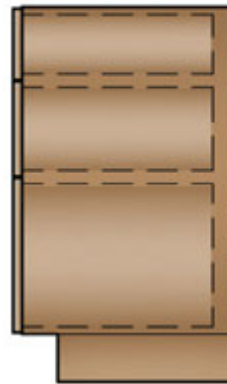

3 drawers 18 x 1 1/2' = 81" drawer storage  
Total: 81" drawer storage



3 shelves 24" x 1' = 72" wall storage  
Total: 72" wall storage

15" 12"



3 shelves 24" x 1 1/4' = 90" wall storage  
Total: 90" wall storage



6 shelves 24" x 1' = 144" pantry storage  
Total: 144" wall storage

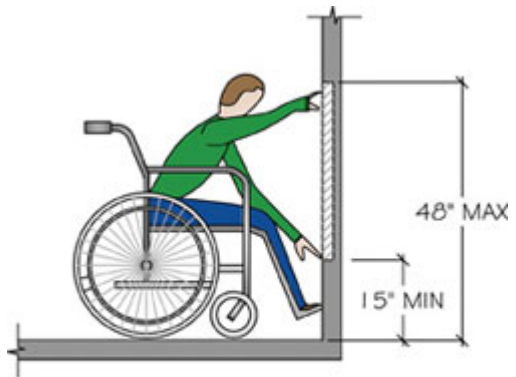

UNOBSTRUCTED FORWARD REACH

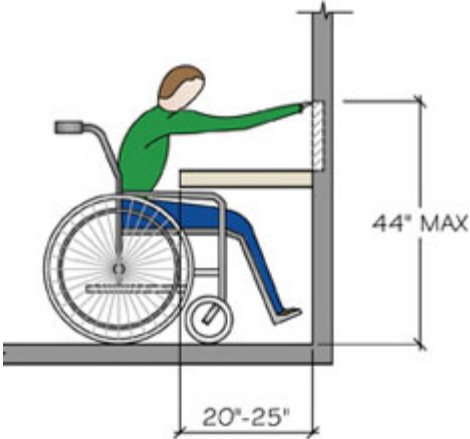

OBSTRUCTED HIGH FORWARD REACH

## 28: Storage at cleanup/Prep Sink

### Recommended:

Of the total recommended wall, base, drawer and pantry shelf/drawer frontage, the following should be located within 72" of the centerline of the main cleanup/prep sink:

- a. at least 400" for a small kitchen;
- b. at least 480" for a medium kitchen;
- c. at least 560" for a large kitchen.

### Code Requirement:

State or local codes may apply.

### Access Standard

#### Recommended:

Plan storage of frequently used items 15" to 48" above the floor.

#### Code Reference:

See Access Guideline 27 for reach specifications.

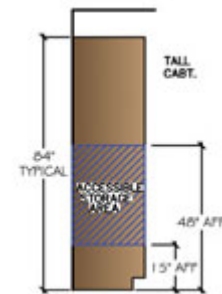
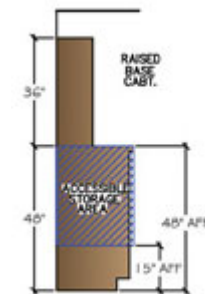
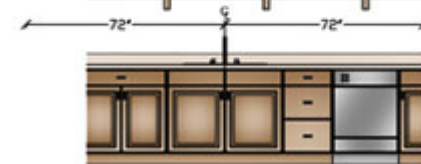
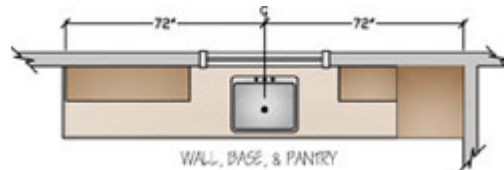
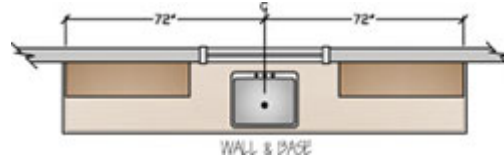
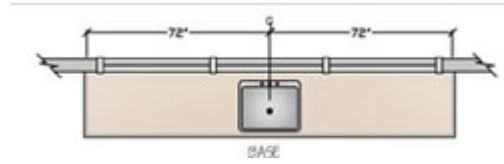



## 29: Corner Cabinet Storage

---

### **Recommended:**

At least one corner cabinet should include a functional storage device

This guideline does not apply if there are no corner cabinets.

### **Code Requirement:**

State or local codes may apply.

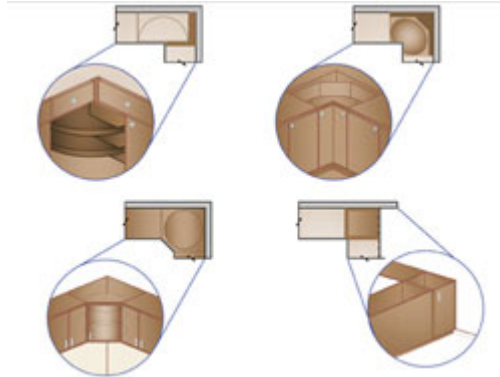

### **Access Standard**

#### **Recommended:**

Kitchen guideline recommendation meets Access Standard.

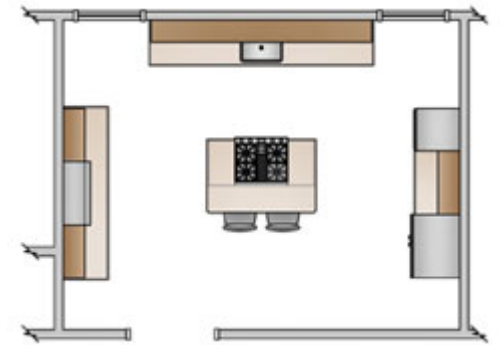

## 30: Electrical Receptacles

---

### **Requirement:**

GFCI (Ground-fault circuit-interrupter) protection is required on all receptacles servicing countertop surfaces within the kitchen. (IRC E 3802.6)

Refer to IRC E 3801.4.1 thru E 3801.4.5 for receptacle placement and locations.

### **Access Standard**

#### **Recommended:**

See Code Reference.

#### **Code Reference:**

See Access Standard 19 for reach and control specifications.

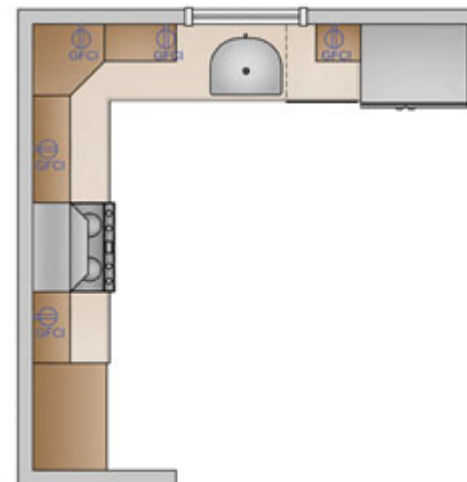

## 31: Lighting

---

### **Recommended:**

In addition to general lighting required by code, every work surface should be well illuminated by appropriate task lighting.

### **Code Requirement:**

At least one wall-switch controlled light must be provided. Switch must be placed at the entrance. (IRC E 3803.2)

Window/skylight area, equal to at least 8% of the total square footage of the kitchen, or a total living space which includes a kitchen, is required. (IRC R 303.1, IRC R 303.2)

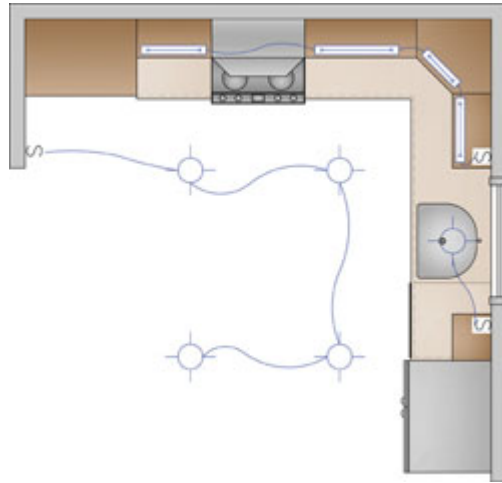

### **Access Standard**

#### **Recommended:**

Lighting should be from multiple sources and adjustable

#### **Code Reference:**

See Access Standard 19 for reach and control specifications.